

# **ERSATZTEILLISTE**

## **RUTHENBERG**

**Zwiebelvorratsroder**

**ZVR 1350**

**ZVR 1650**

**Ruthenberg Landtechnik  
Schlingbreite 5  
33332 Gütersloh**

**Tel.: +49(0)5241/703133**

**Fax: +49(0)5241/703332**

**Autotel.: 01725484402**



# **Ersatzteilliste - Inhaltsverzeichnis**

	<b>Seite</b>
<b>Rahmen</b>	<b>5</b>
<b>Rüttler</b>	<b>7</b>
<b>Ablage</b>	<b>9</b>
<b>Hauben und Abdeckungen</b>	<b>11</b>
<b>Walze</b>	<b>13</b>
<b>Baugruppenantrieb</b>	<b>15</b>
<b>Schar</b>	<b>17</b>
<b>Sech</b>	<b>17</b>
<b>Paddel und Antrieb</b>	<b>19</b>
<b>Rodewelle</b>	<b>21</b>
<b>Siebketten</b>	<b>23</b>
<b>Klappe</b>	<b>25</b>
<b>Schlepprahmen</b>	<b>27</b>

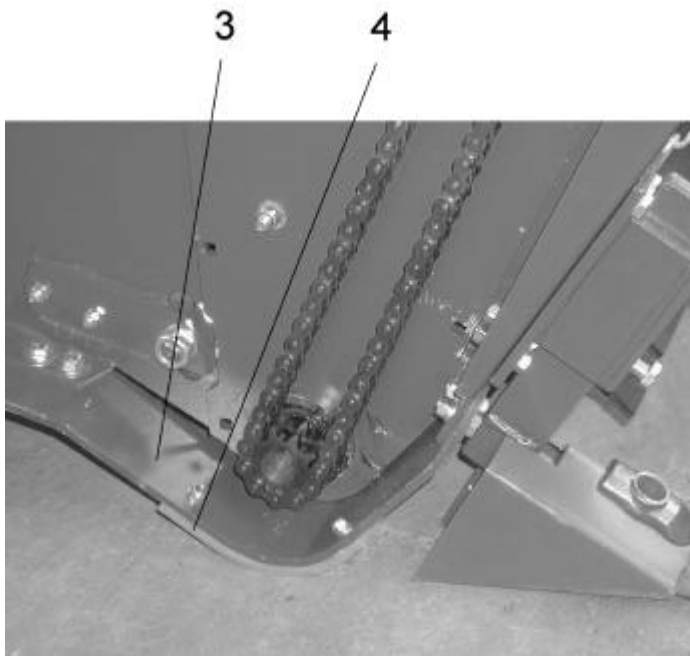
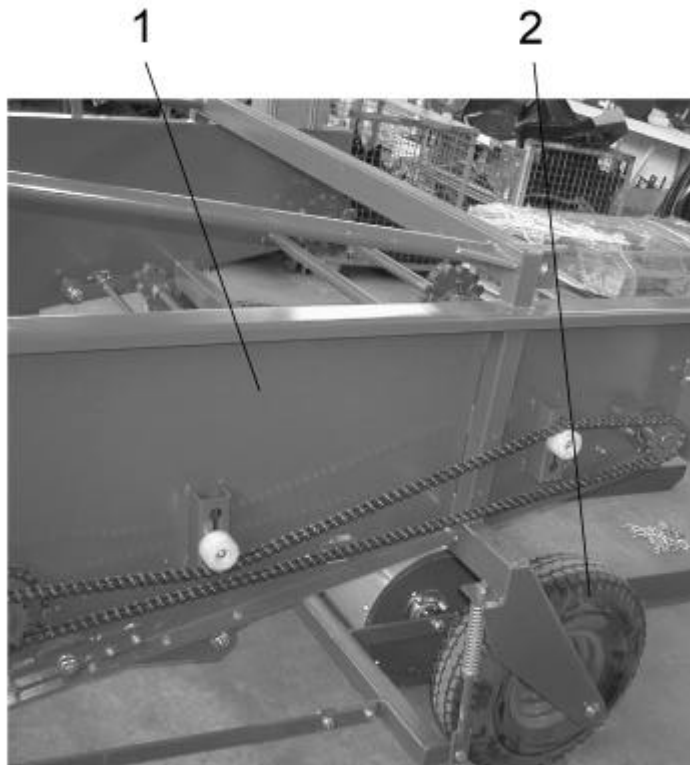

## Rahmen

Nr.	Bezeichnung	Anzahl	Teile-Nr.
1	Rahmen	2	ZR010114
2	Stützräder 6.00-9 6PR 540x170	2	ZR500001
3	Kufe	1	ZR050148
4	Belag	1	ZR050147

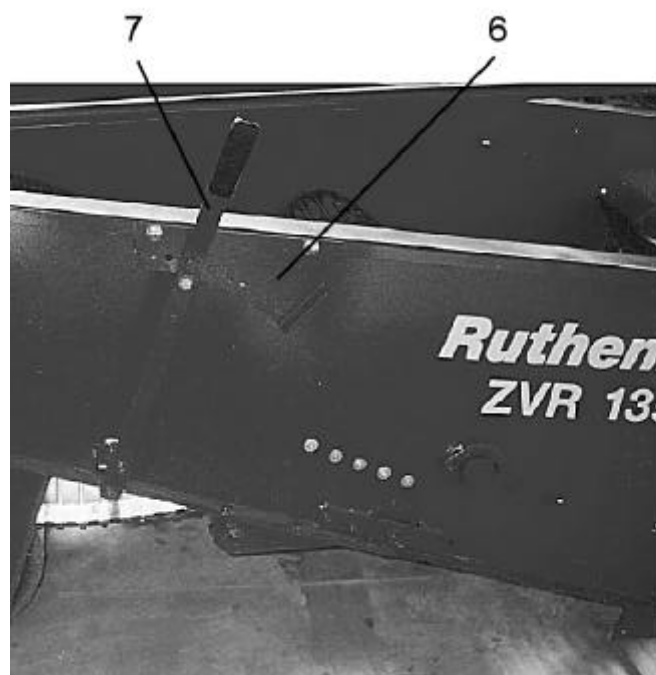
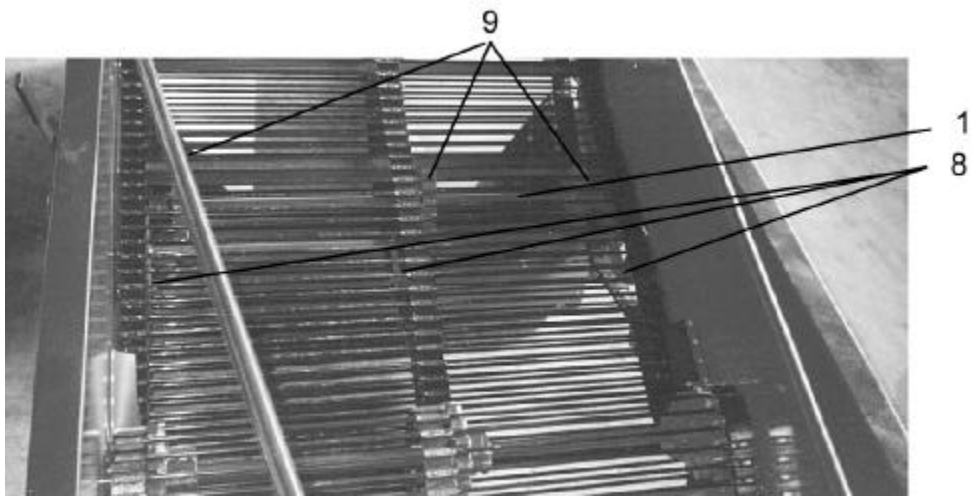
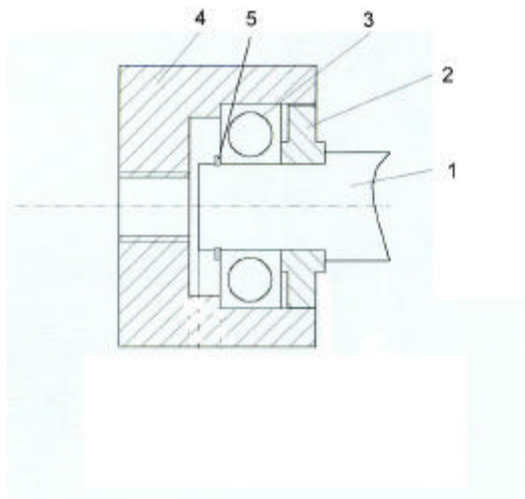

## Rüttler

Nr.	Bezeichnung	Anzahl	Teile-Nr.
1	Welle	1	ZR010310
2	Dichtung	2	ZR010309
3	Lager	2	6204 2RS
4	Gehäuse	2	ZR010308
5	Seegerring	2	A20
6	Segment	1	ZR060301
7	Hebel	1	ZR060302
8	Stützrolle gummiert	3	ZR500002
9	Rüttlersterne	3	ZR500003

# Ablage

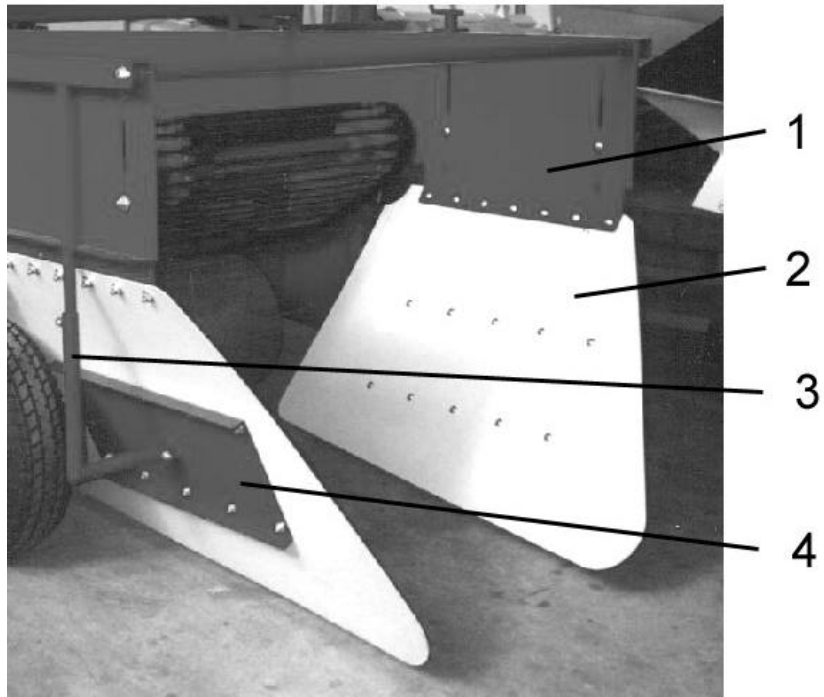

## Ablage

Nr.	Bezeichnung	Anzahl	Teile-Nr.
1	Verstellblech	2	ZR010502
2	Ablageplatte GVR1350	2	ZR010503
	Ablageplatte GVR1650	2	ZR010512
3	Aufnahme	2	ZR010510
4	Blech Ablage	2	ZR010507

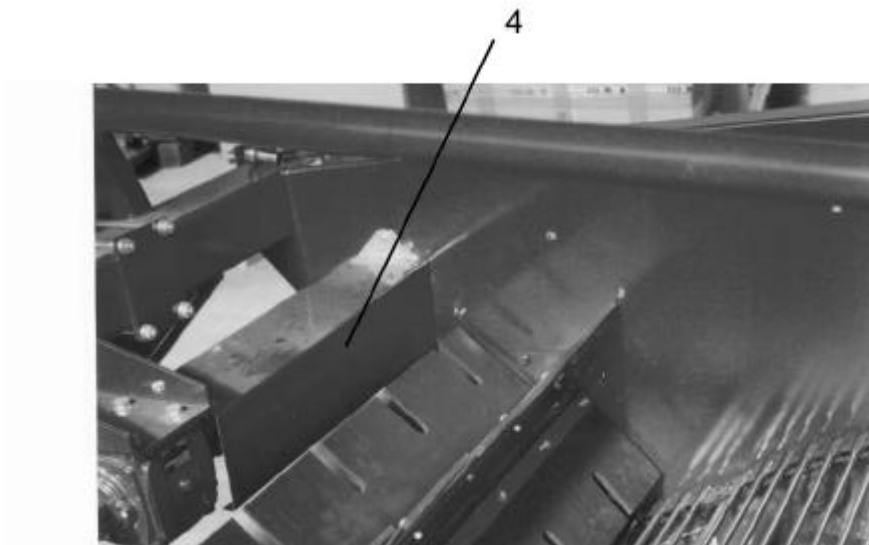
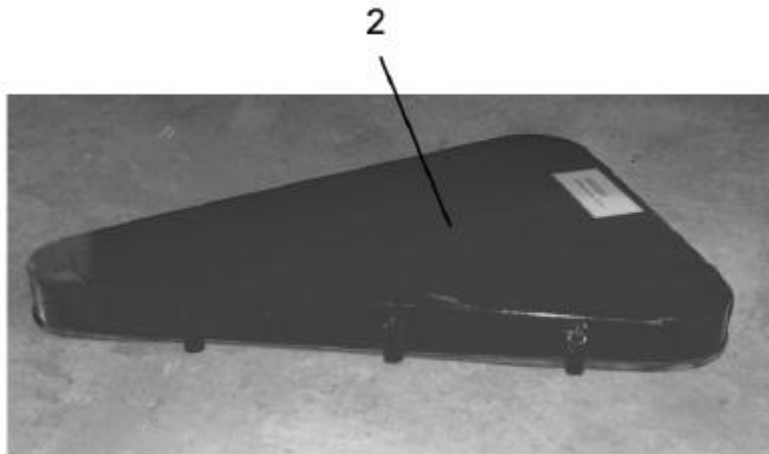
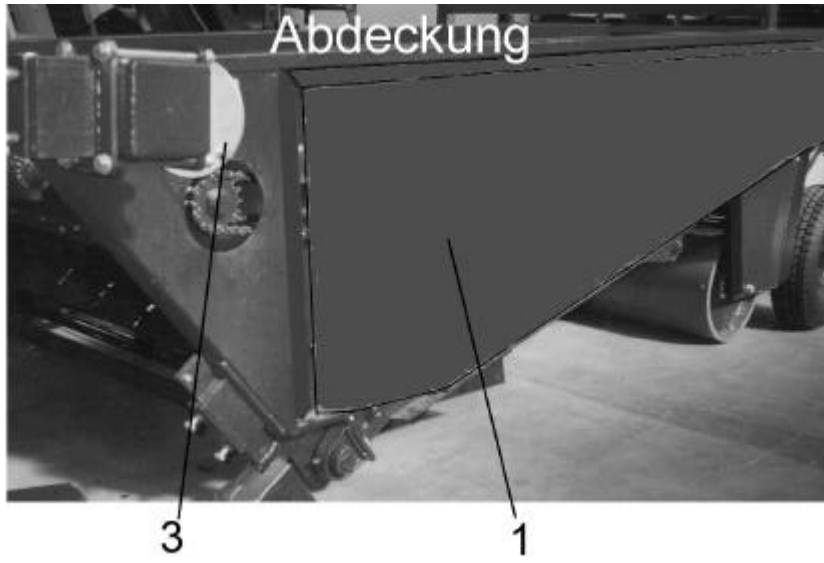

## Hauben und Abdeckungen

Nr.	Bezeichnung	Anzahl	Teile-Nr.
1	Haube links	1	ZR050601
2	Haube rechts	1	ZR050602
3	Scheibe	1	ZR010604
4	Abdeckung Antriebswelle GVR 1350	2	ZR010801
	Abdeckung Antriebswelle GVR 1650	2	ZR010816

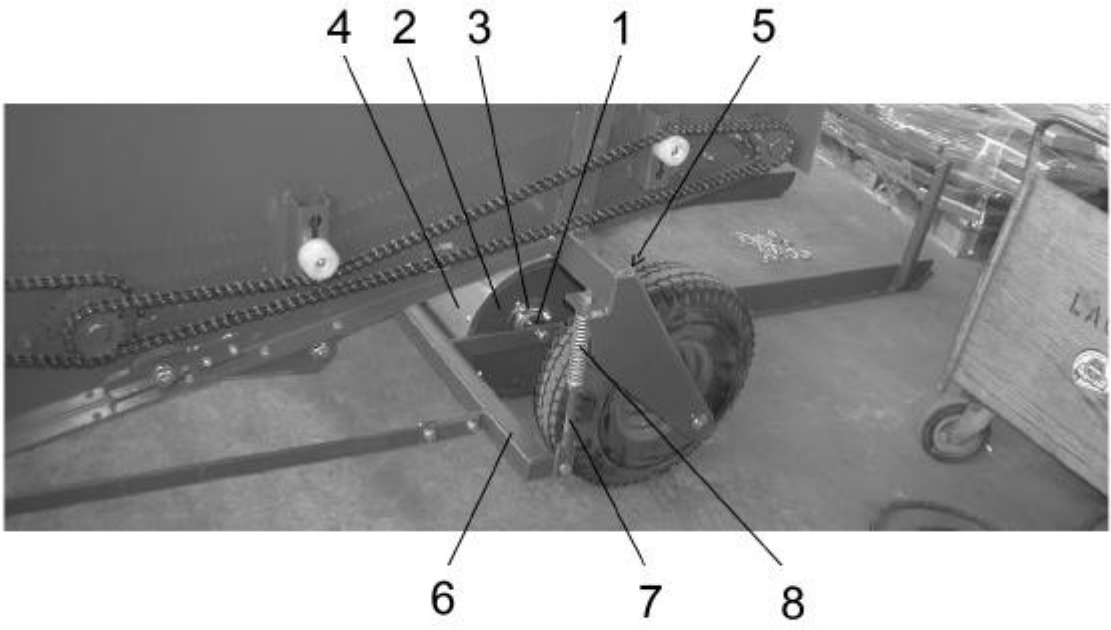

## Walze

Nr.	Bezeichnung	Anzahl	Teile-Nr.
1	Welle	1	ZR010704
2	Lagerscheibe	2	ZR010706
3	Lager	2	RA35
4	Walzenmantel	1	ZR010712
5	Abstreifer	1	ZR010710
6	Rahmen Walze	1	ZR010709
7	Spindel	2	ZR010708
8	Druckfeder	2	ZR500004

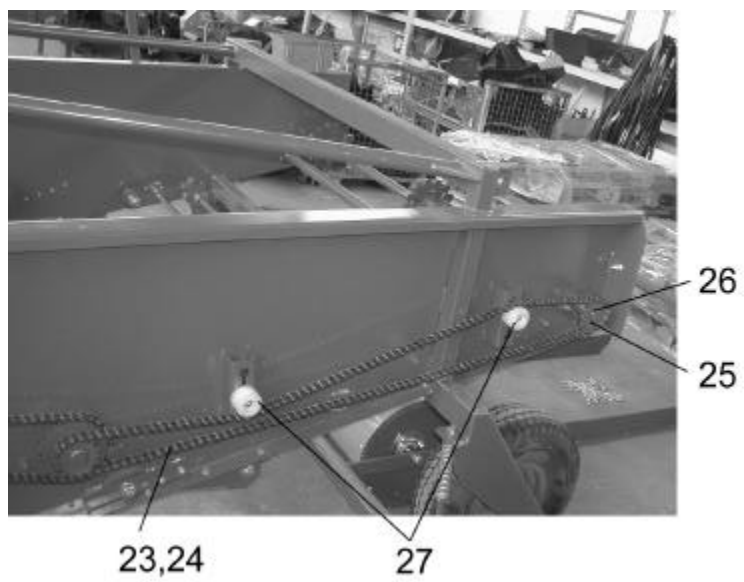
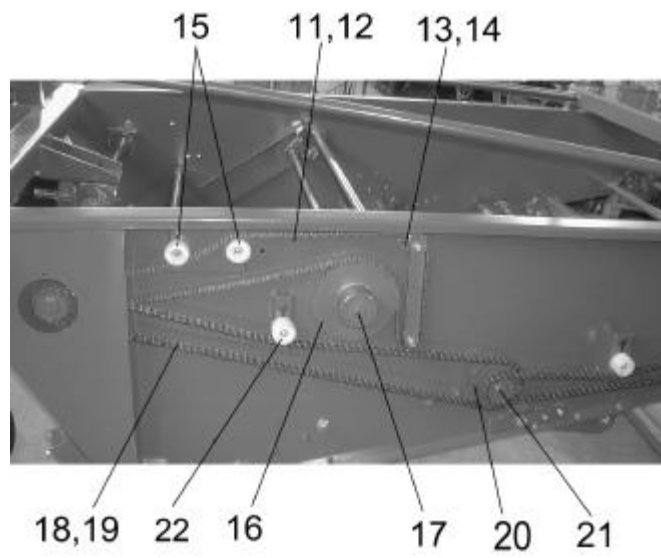
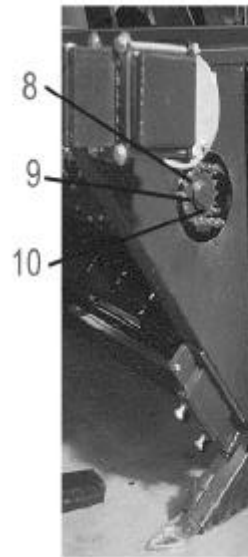
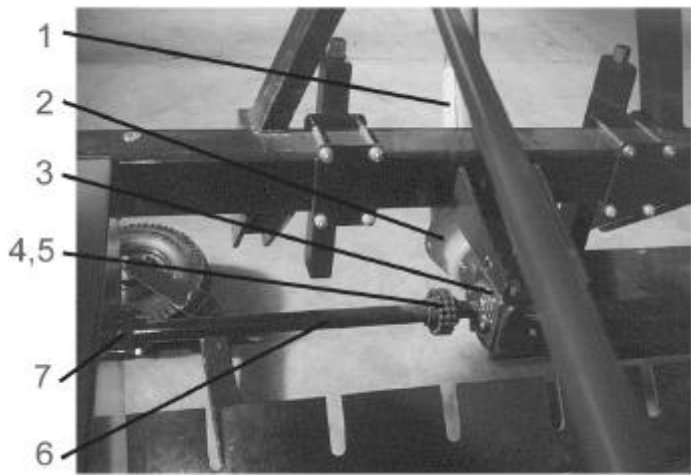

## Baugruppenantrieb

Nr.	Bezeichnung	Anzahl	Teile-Nr.
<b><u>Hauptantrieb</u></b>			
1	Gelenkwelle	1	ZR500005
2	Zapfwellenschutz	1	ZR500006
3	Getriebe	1	ZR500007
	Getriebeöl		0,7 ltr
4	Kettenkupplung Kettenrad	4	ZR010817
	Duplexkette	2	ZR500008
5	Paßfeder	4	A8x7x21
6	Hauptantriebswelle	2	ZR010809
	GVR 1350 L=607 /GVR 1650 L=757		
7	Flanschlager	2	FW207 NTB
8	Doppelkettenrad Hauptantrieb	1	ZR010809
	1/2" z=18 / 3/4"z=15		
9	Paßfeder	1	A10x8x36
10	Sicherungsring	1	A35x1,5
<b><u>Antrieb linke Seite</u></b>			
<b>Paddelantrieb</b>			
11	Kette 1/2	1	ZR500009
12	Kettenschloß 1/2	1	ZR500010
13	Kettenumlenkrad 1/2 z=	2	ZR500011
14	Distanzstück	2	ZR010808
15	Polyamidspannklotz	2	ZR010813, L=15
16	Antriebskettenrad z=58	1	ZR020810
	mit Passfeder	1	A8x7x30
17	Sicherungsring	1	A30x1,5
<b>Antrieb 1. Siebkette</b>			
18	Kette 3/4	1	ZR500012
19	Kettenschloß 3/4	1	ZR500013
20	Doppelkettenrad 3/4	1	ZR010812
	Z=15/Z=25		
	mit Passfeder	1	A10x8x36
21	Sicherungsring	1	A35x1,5
22	Polyamidspannklotz	1	ZR010813, L=50
<b>Antrieb 2. Siebkette</b>			
23	Kette 3/4	1	ZR500014
24	Kettenschloß 3/4	1	ZR500013
25	Kettenrad 3/4 Z=15	1	ZR010811
	mit Passfeder	1	A10x8x36
26	Sicherungsring	1	A35x1,5
27	Polyamidspannklotz	1	ZR010813, L=40

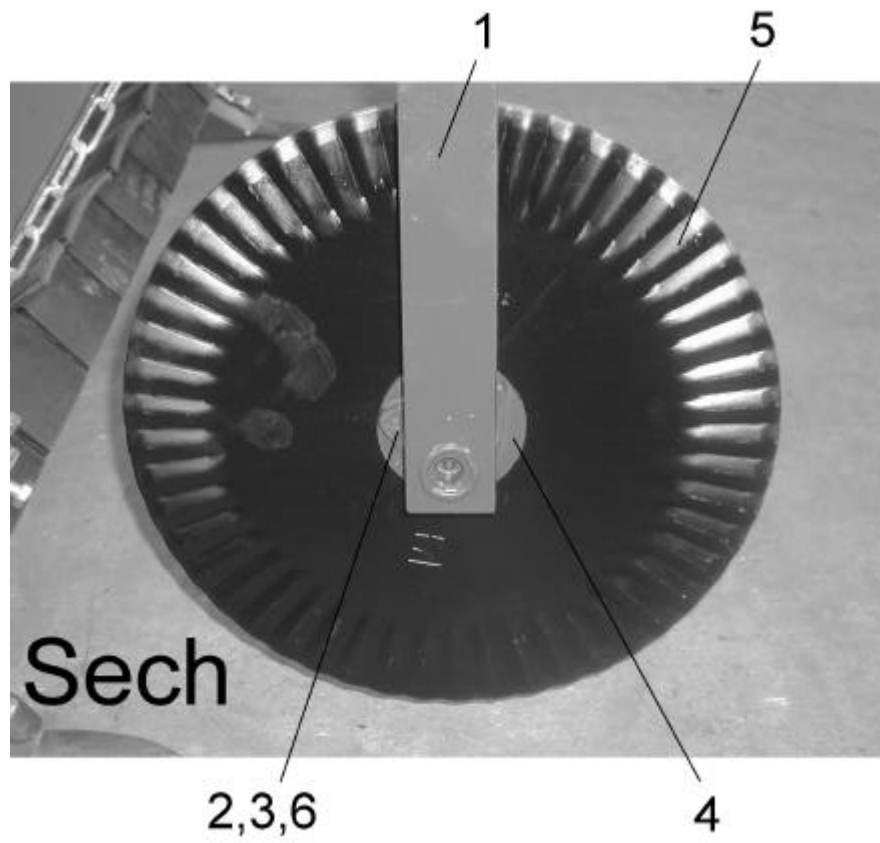
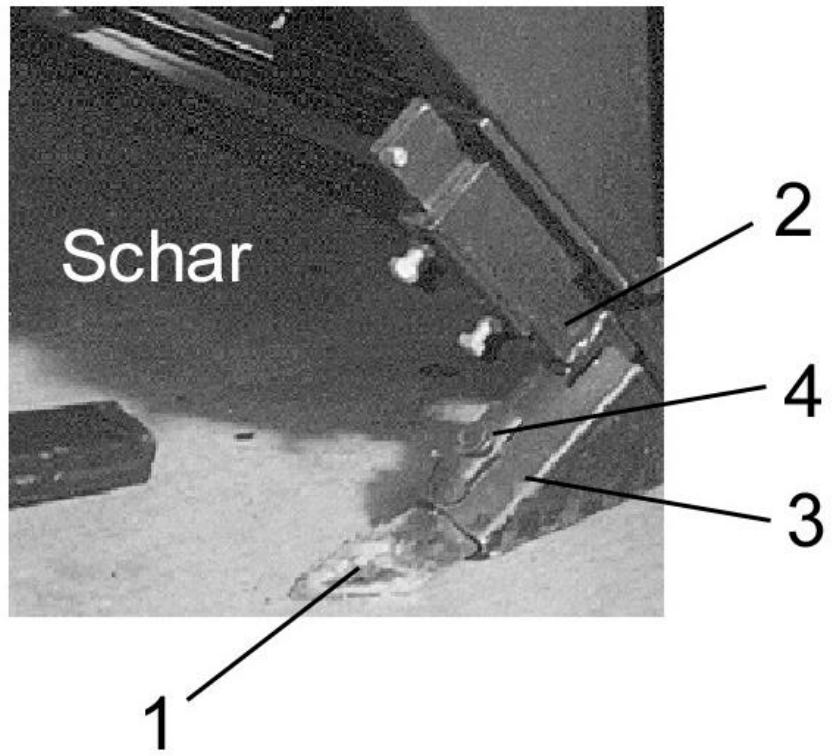

<b>Schar</b>			
Nr.	Bezeichnung	Anzahl	Teile-Nr.
1	Schar	2	ZR500015
2	Scharhalter	2	ZR010902
3	Abdeckung	2	ZR010907
4	Scharschraube	2	ZR500016

<b>Sech</b>			
Nr.	Bezeichnung	Anzahl	Teile-Nr.
1	Halter	2	ZR011001
2	Aufnahme	2	ZR011002
3	Gegenstück	2	ZR011003
4	Nabe	2	ZR011005
5	Sech Ø	2	ZR500017
6	Lagerung	2	ZR500038

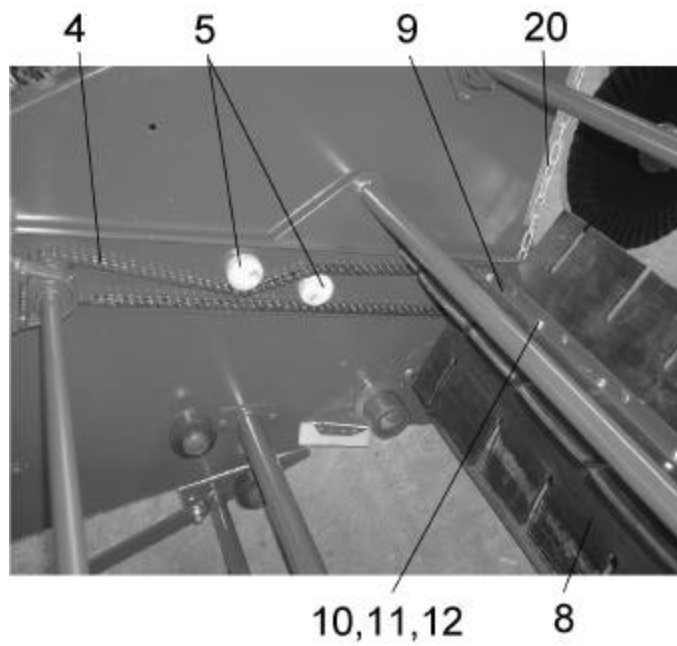
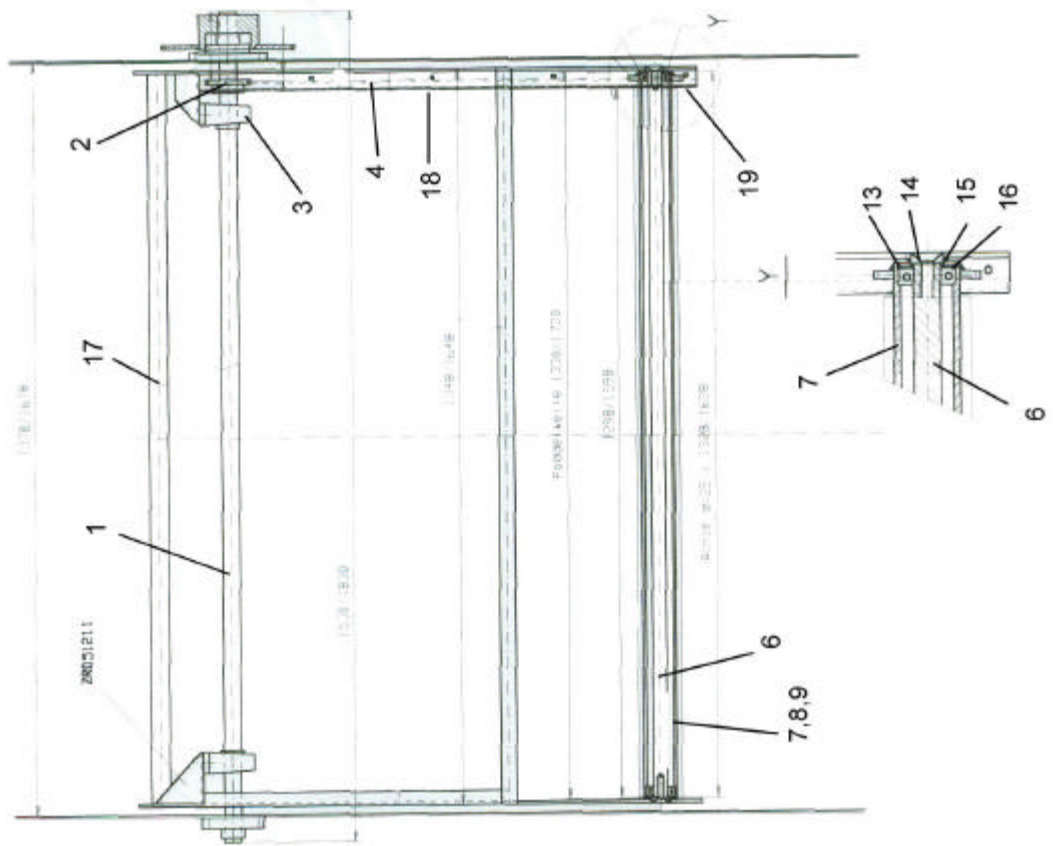

## Paddel und Antrieb

Nr.	Bezeichnung	Anzahl	Teile-Nr.
1	Antriebswelle GVR 1350 L= 1530 GVR 1650 L= 1850	1	ZR020818
2	Kettenrad 5/8" z=15	1	ZR051220
3	Stehlager SWG30	2	
4	Kette 5/8"	1	ZR500018
5	Kettenspannklotz	2	ZR051217
6	Achse Paddelwelle GVR 1350 L= 1328 GVR 1650 L= 1628	1	ZR051215
7	Paddelwelle	1	ZR051201
8	Paddelgummi GVR1350	4	ZR021203
	Paddelgummi GVR1650	4	ZR021204
9	Klemmleiste GVR1350	4	ZR021202
	Klemmleiste GVR1650	4	ZR021205
10	Schraube M8x30	36/40	(GVR 1350/1650)
11	Mutter M8	36/40	(GVR 1350/1650)
12	Scheibe A8,4	72/80	(GVR 1350/1650)
13	Seegerring	2	I50
14	Buchse	2	ZR051216
15	Stützring	4	Ø25x2
16	Lager	2	6205 2RS
17	Rahmen	1	ZR051200
18	Abdeckung	1	ZR050608
19	Abdeckung	1	ZR050610
20	Kette Auhängung	2	ZR500037

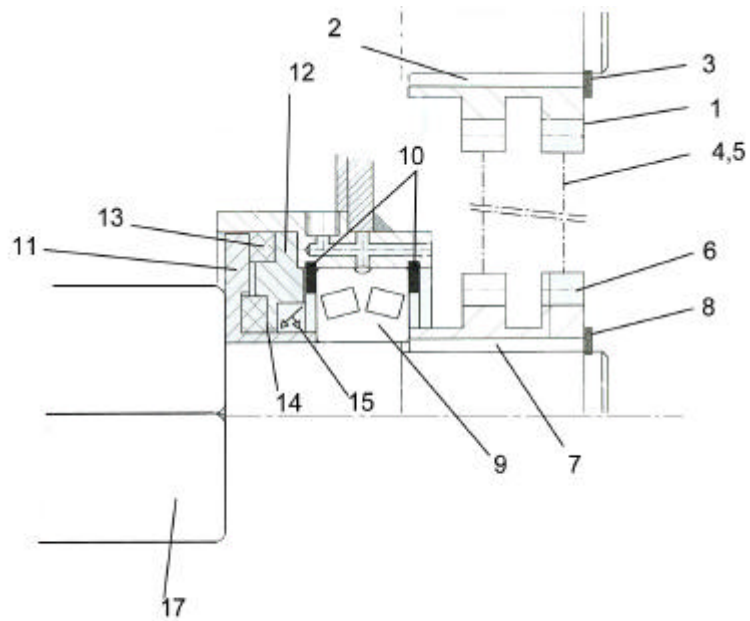
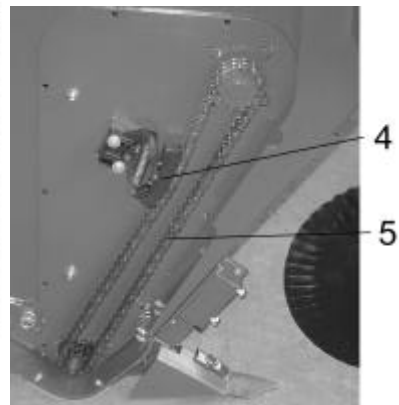
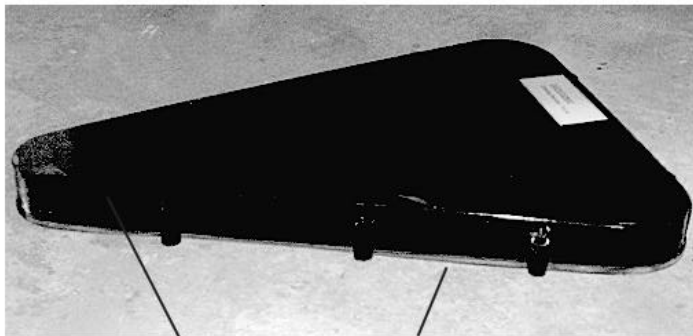
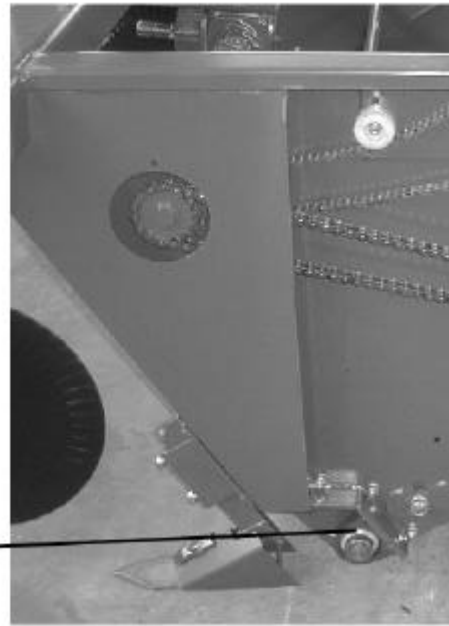
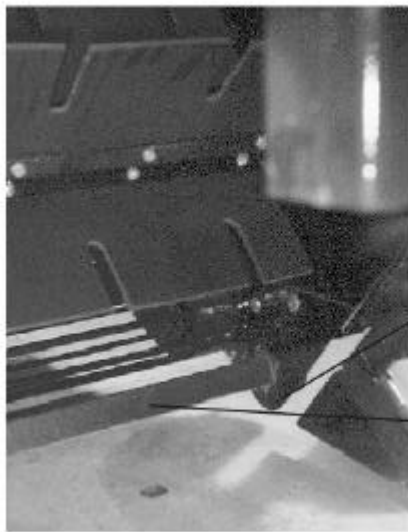

## Rodewelle

Nr.	Bezeichnung	Anzahl	Teile-Nr.
1	Duplexkettenrad z=13 $\frac{3}{4}$	1	ZR010814
2	Paßfeder	1	A10x8x36
3	Sicherungsring	1	A35x1,5
4	automat.Kettenspanner	1	ZR500019
5	Duplex- Kette 3/4"	1	ZR500020
6	Duplexkettenrad z=10 $\frac{3}{4}$	1	ZR010815
7	Paßfeder	1	8x7x36
8	Sicherungsring	1	A30x1,5
9	Pendellager	1	22207 ES
10	Sicherungsring	2	I 72x2,5
11	Anlaufscheibe	1	ZR051104
12	Aufnahme Filzring	1	ZR051105
13	Filzring 90x75x8	1	ZR500021
14	Filzring 58x40x8	1	ZR500022
15	Wellendichtring 40x55x7	1	ZR500023
16	Abdeckung	1	ZR010105
17	Rodewelle	1	ZR011101
	GVR 1350 L=1515		
	GVR 1650 L=1815		
18	Stehlager	1	RSHE 35
19	Haube	1	ZR010602
20	Dichtgummi	1	ZR500024
21	Fließfett	1,5 ltr.	ZR500025

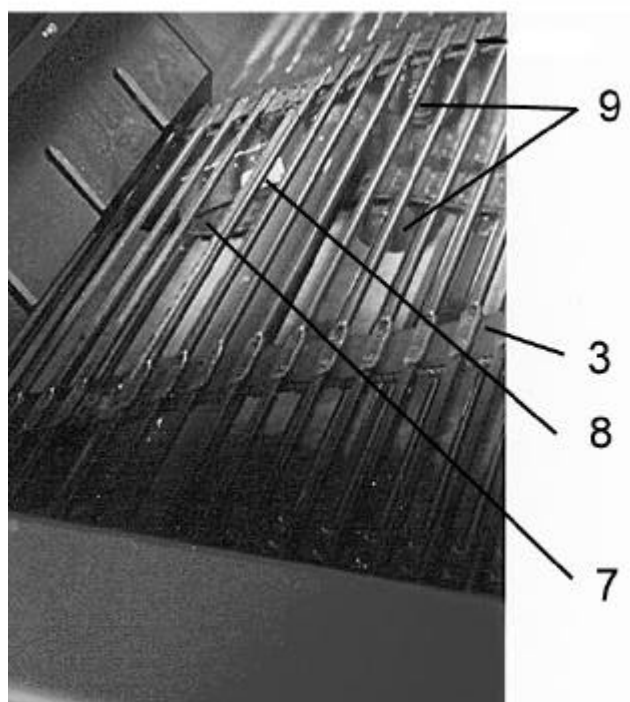
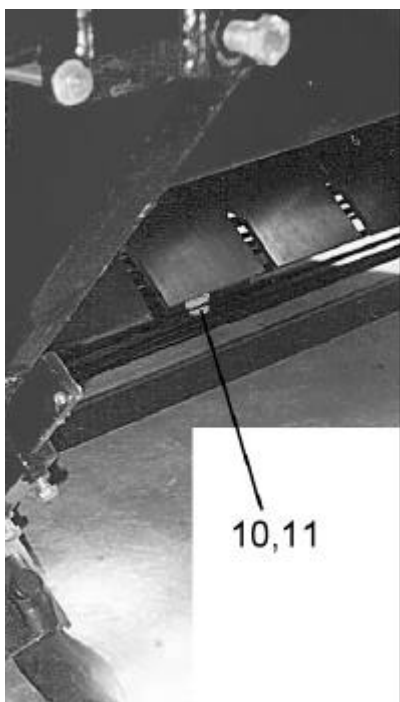
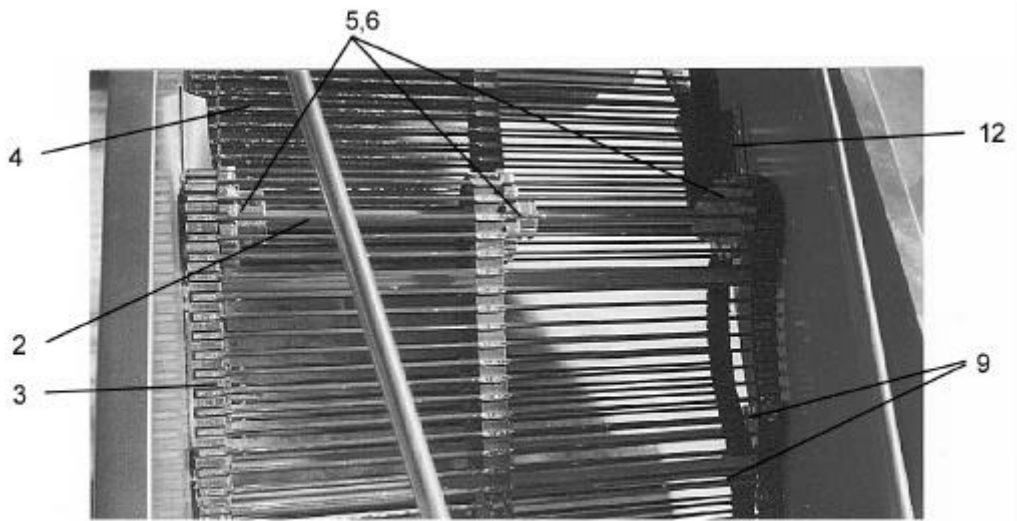
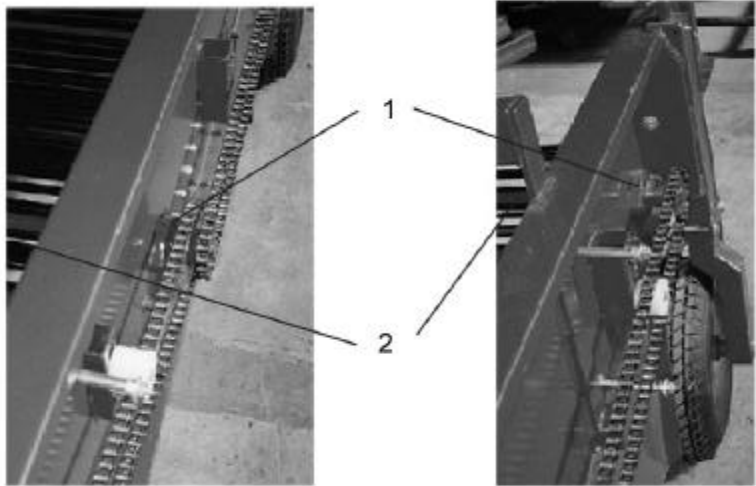

## Siebketten

Nr.	Bezeichnung	Anzahl	Teile-Nr.
1	Flanschlager	4	FW207 NTB
2	Siebkettenwelle GVR 1350 L=1530 GVR 1650 L=1830	2	ZR010806
3	1. Siebkette		
	<u>GVR 1350</u>	1	ZR500026
	Gurt	3	ZR500039
	Einzelstab		ZR500040
	Niet		ZR500041
	Schlossstab		ZR500042
	Schloßlaschen		ZR500043
	<u>GVR 1650</u>	1	ZR500027
	Gurt	3	ZR500044
	Einzelstab		ZR500045
	Niet		ZR500041
	Schlossstab		ZR500046
	Schloßlaschen		ZR500043
4	2. Siebkette		
	<u>GVR 1350</u>	1	ZR500028
	Gurt	3	ZR500047
	Einzelstab		ZR500040
	Niet		ZR500041
	Schlossstab		ZR500042
	Schloßlaschen		ZR500043
	<u>GVR 1650</u>	1	ZR500029
	Gurt	3	ZR500048
	Einzelstab		ZR500045
	Niet		ZR500041
	Schlossstab		ZR500046
	Schloßlaschen		ZR500043
5	Antriebsstern	6	ZR500030
6	Befestigungsschrauben	24	ZR500031
7	Umlenkrolle	4	ZR500032
8	Abstreifer	4	ZR500033
9	Stützrolle	6	ZR500034
10	Stützrolle Mitte1.Siebketten	1	ZR500035
11	Abstreifer Mitte1.Siebketten	1	ZR010126
12	Abstreifer 2.Siebketten	2	ZR500036

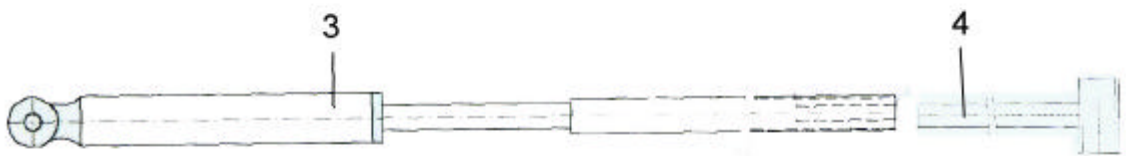
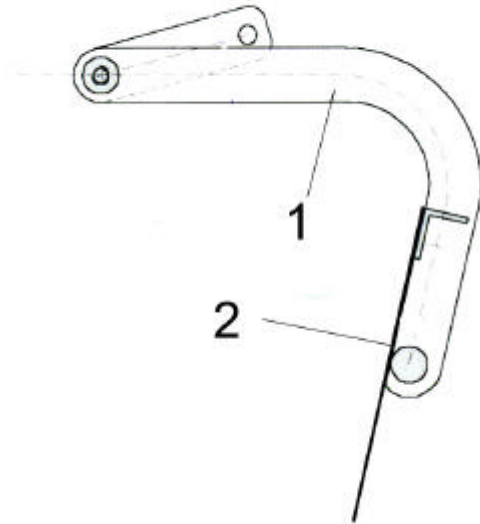

## Klappe

Nr.	Bezeichnung	Anzahl	Teile-Nr.
1	Rahmen	1	ZR011403
2	Klappengummi GVR 1350 L=1340 GVR 1650 L=1640	1	ZR011407
3	Klappzylinder	1	ZR101406
4	Spindel	1	ZR011404

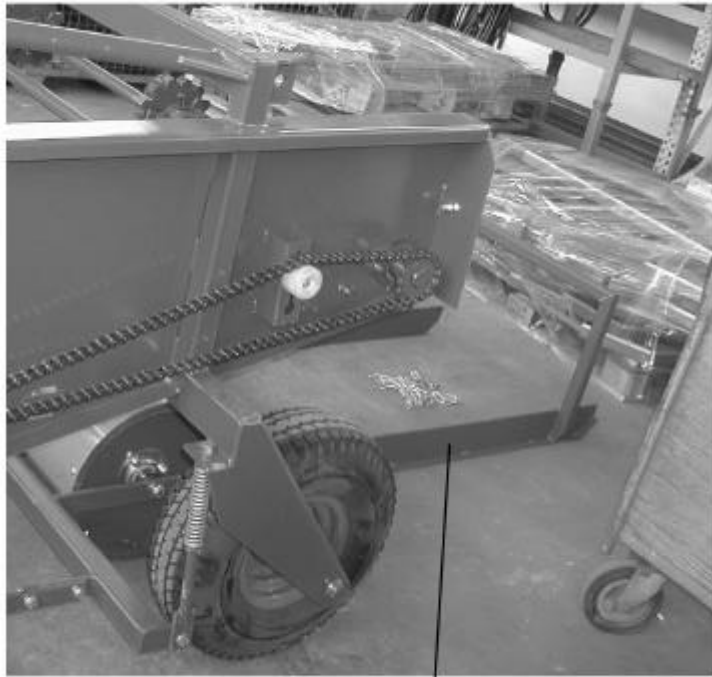

1,2

## **Schlepprahmen**

Nr.	Bezeichnung	Anzahl	Teile-Nr.
1	Rahmen	1	ZR011501
2	Kette	2	ZR500037